



Pali Design, Inc.

1525 Hymus Boul.
Dorval, QC
H9P-1J5 Canada
Phone: 1-514-421-0309



customerservice@pali-design.com

www.pali-design.com

Assembly Instructions

Onda Armoire

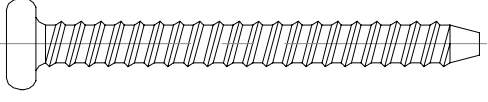
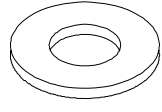
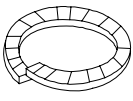
Hardware Parts List

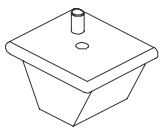
A Allenhead Bolt  4x	B Metal Washer  4x	
C Spring Washer  4x	D Allen Wrench  1x	
Parts List:		INSTRUCTION LEAFLET
E Foot  4x	Important, keep for future reference. Read carefully.	
		Adult assembly is required.

Double Dresser

Step 1

Assembling Onda Armoire

Hardware Preparation

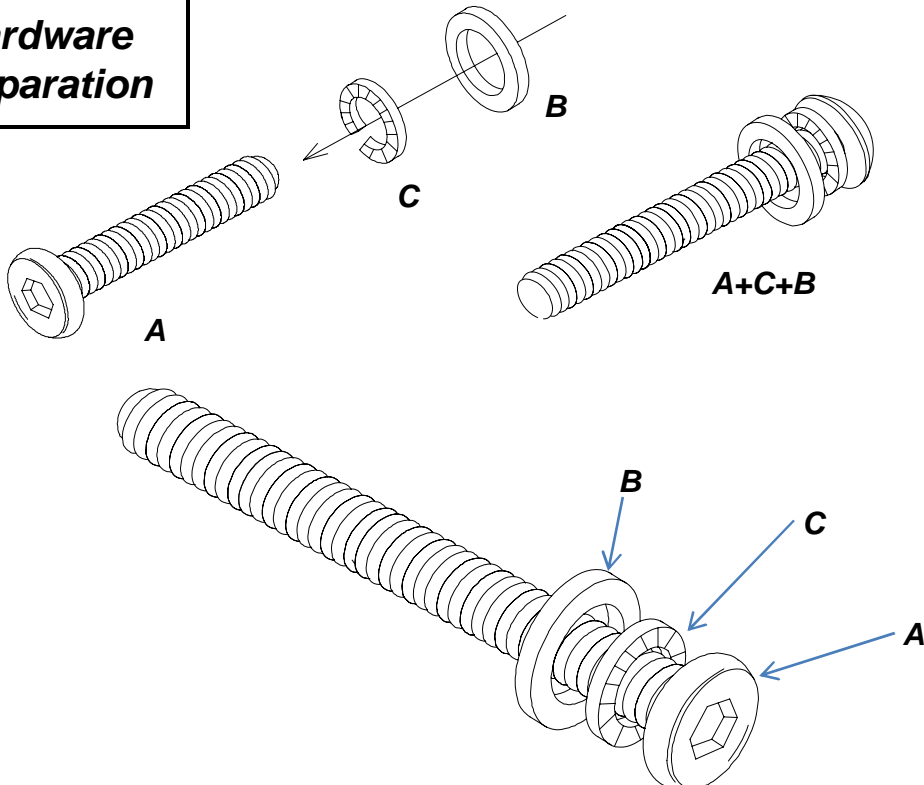

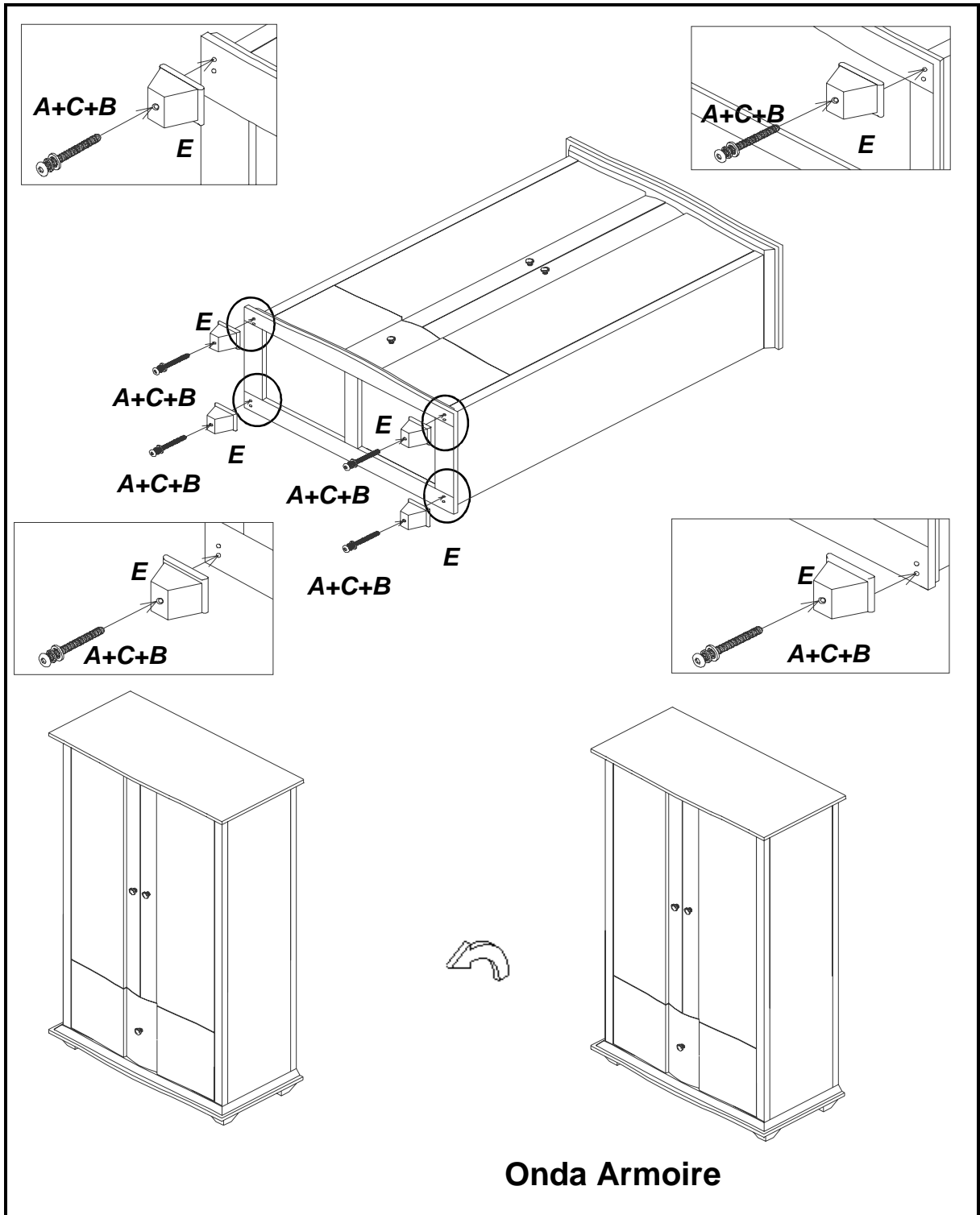

Onda Armoire



CARE AND MAINTENANCE

When cleaning your furniture, please use a non-toxic, non-abrasive cleaner. Mix a solution of water with a small amount of mild dishwashing liquid. Apply to furniture surface with a soft, damp cloth lightly dampened in solution. After cleaning, dry completely with a soft, dry cloth.