



Pali Design, Inc.

1525 Hymus Boul.

Dorval, QC

H9P-1J5 Canada

Phone: 1-514-421-0309



customerservice@pali-design.com

www.pali-design.com

Assembly Instruction

Imperia Toddler Rail

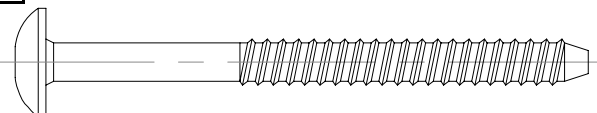
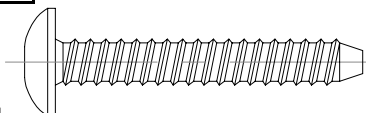
Hardware Parts List

A Round Allenhead Bolt  8x	B Round Allenhead Bolt  4x	C Allen Wrench  1x
---	--	---

Toddler Rail Part List

INSTRUCTION LEAFLET

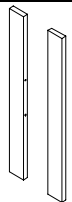
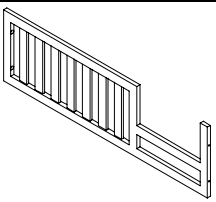
 2 x Post	 1 x Toddler Rail
--	--

Important, keep for future reference. Read carefully.

Adult assembly is required.

Toddler Bed & Child's Day Bed

Transforming Crib into a Toddler Bed and a Child's Day Bed

When using the crib as a child's day bed or toddler bed, remove the Footboard and the lower mattress support position must be used.

Toddler Bed

Step **1**

Remove Mattress Support

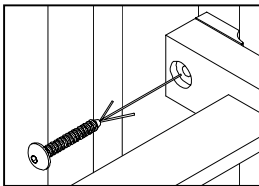

Back

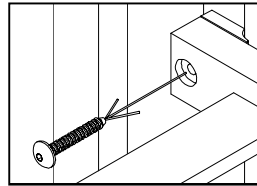

Back

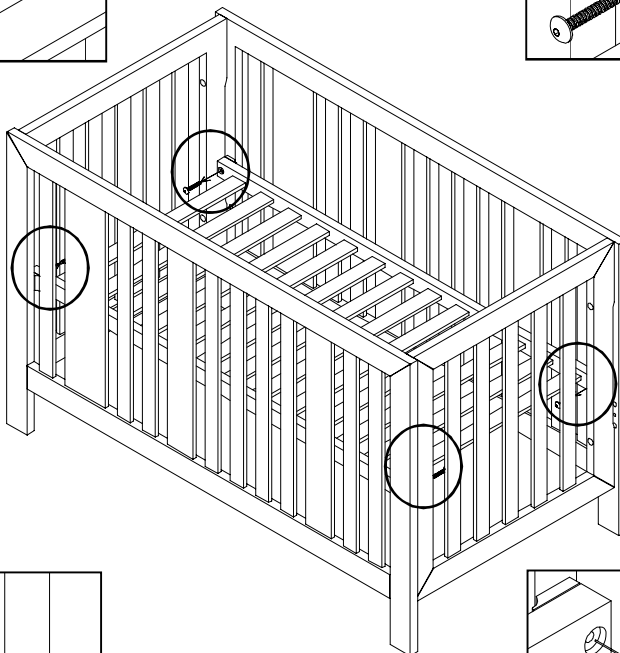

Front

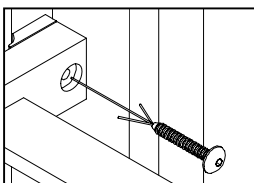

Front

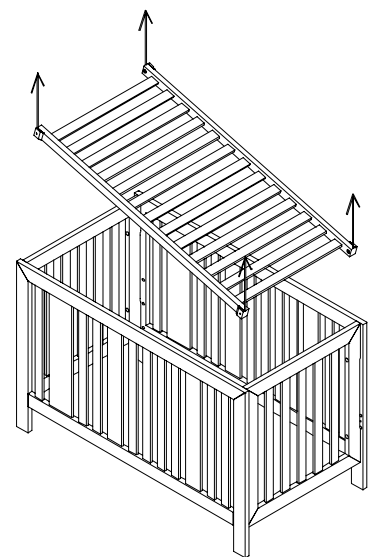
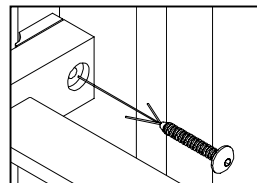

Note: Keep all bolts to use in Step 4

Toddler Bed **Step 2** *Remove Footboard*

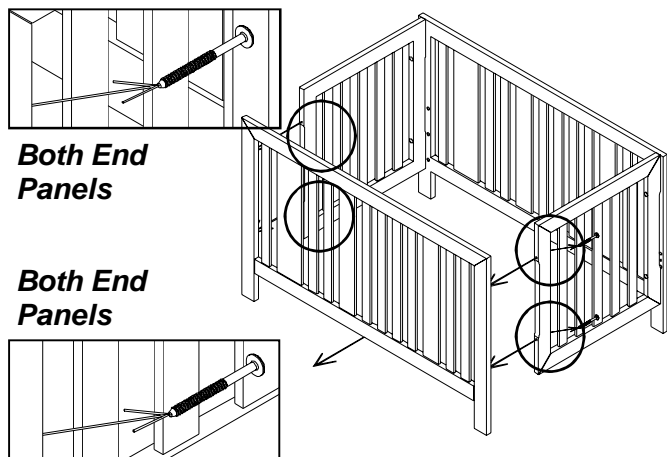

Toddler Bed **Step 3** *Attach Posts*

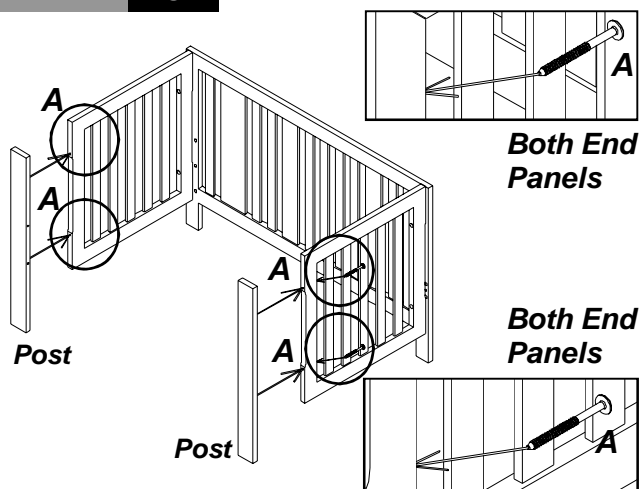

Toddler Bed **Step 4** *Attach Mattress Support*

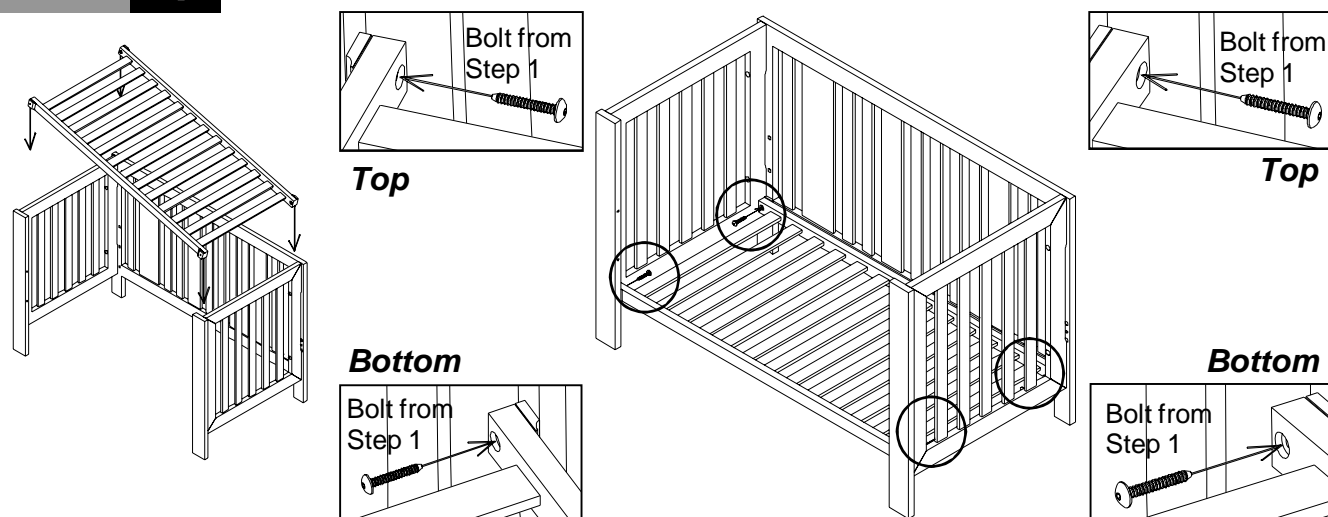

Toddler Bed **Step 5** *Attach Toddler Rail*

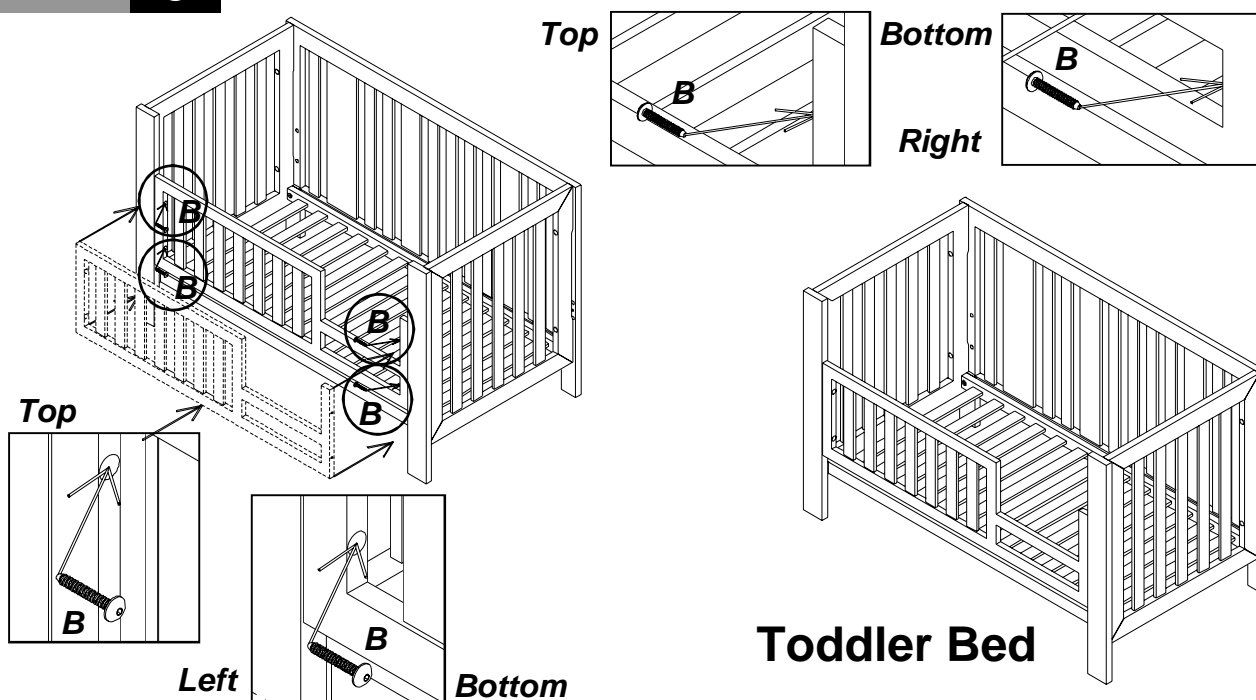

Toddler Bed

Top

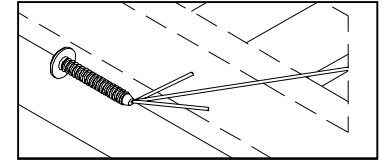
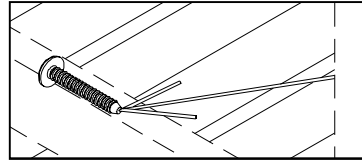

Right

Bottom

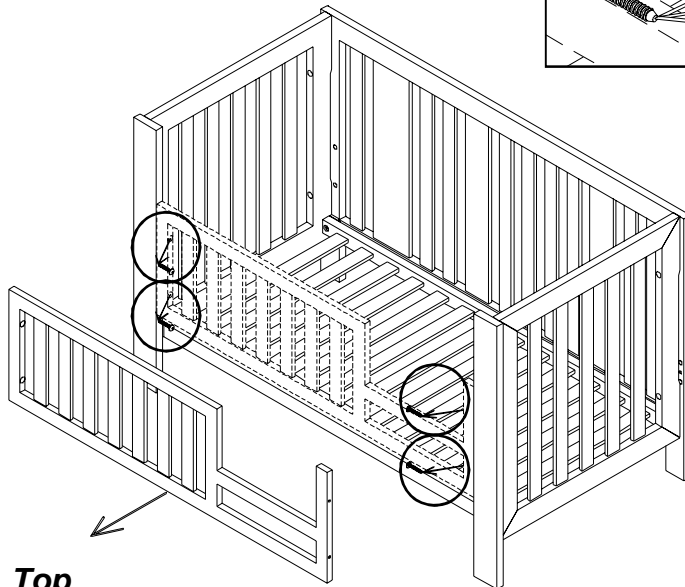

Top

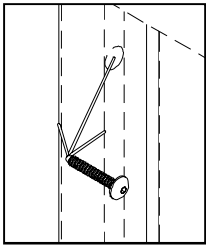

Bottom

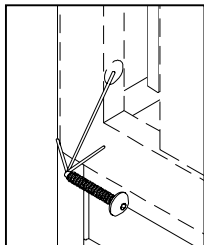

Left



Child's Day Bed



WARNING STATEMENTS

- Read all instructions before assembling crib. **Keep instructions for future use.**
- Failure to follow these warnings and the assembly instructions could result in serious injury or death.
- Never use plastic shipping bags or other plastic film as mattress covers because they can cause suffocation.
- Infants can suffocate in gaps between crib sides and a mattress that is too small.
- Infants can suffocate on soft bedding. Never add a pillow, comforter or padding.
- To reduce the risk of SIDS, pediatricians recommend healthy infants to be placed on their backs to sleep, unless otherwise advised by your physician.
- Strings can cause strangulation! Do not place items with a string around a child's neck, such as hood strings or pacifier cords. Do not suspend strings over a crib or attach strings to toys.
- To help prevent strangulation tighten all fasteners. A child can trap parts of the body or clothing on loose fasteners.
- **DO NOT** place crib near window where cords from blinds or drapes may strangle a child.

- When child is able to pull to a standing position, set mattress to lowest position and remove bumper pads, large toys and other objects that could serve as steps for climbing out.
- When child is able to climb out or reaches the height of 35 in. (90 cm), the crib shall no longer be used.
- Check this product for damaged hardware, loose joints, missing parts or sharp edges before and after assembly and frequently during use. DO NOT use crib if any parts are missing, damaged or broken. Contact Pali for replacement parts and instructional literature if needed. DO NOT substitute parts.
- DO NOT use a water mattress.
- If refinishing, use a non-toxic finish specified for children's products.
- CAUTION: ANY MATTRESS USED IN THIS CRIB MUST BE AT LEAST 27 1/4 IN. (69 CM) BY 51 5/8 IN. (131 CM) WITH A THICKNESS NOT EXCEEDING 6 IN. (15 CM)



TODDLER BED WARNING STATEMENTS

- Failure to follow these warnings and assembly instructions could result in serious injury or death from entrapment or strangulation.
- DO NOT place bed near window where cords from blinds or drapes may strangle a child.
- The mattress intended for use on the bed shall be a full-size crib mattress having minimum dimensions of 51 5/8 in. (1310mm) in length, 27 1/4 in. (690mm) in width and 4 in. (100mm) in thickness.
- Strings can cause strangulation! Do not place items with a string, cord or ribbon around a child's neck, such as hood strings or pacifier cords. Do not suspend strings over a toddler bed for any reason or attach strings to toys.
- The minimum age of the intended user shall not be less than 15 months and the maximum weight shall not be greater than 50 lbs. (22.7kg).
- The guardrail provided must be used to avoid the formation of a gap between the mattress and the bed that could cause an entrapment.



CARE AND MAINTENANCE

- When cleaning your crib, please use a non-toxic, non-abrasive cleaner. Mix a solution of water with a small amount of mild dishwashing liquid. Apply to crib surface with a soft, damp cloth lightly dampened in solution. After cleaning, dry completely with a soft, dry cloth.
- When storing crib use caution as extreme changes in temperature or humidity can compromise the crib making it extremely dangerous to your child.